

AG Series Electric Adaptive Gripper

AG-160-95
AG-105-145
DH-3

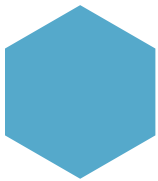

The AG series is a linkage-type adaptive electric gripper which is independently developed by DH-Robotics. With Plug& Play software many and exquisite structural design , AG series is a perfect solution to be applied with collabrative robots to grip work-pieces with different shapes in different industries.



Installation

1. Bottom installation: use bottom screw holes for installation

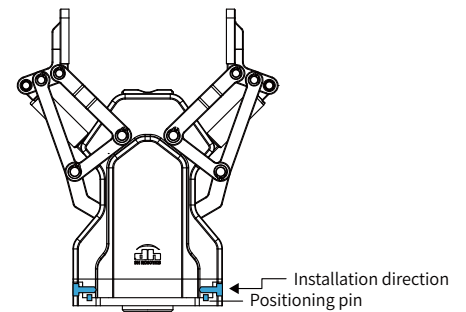

Product Features

● Envelope Adaptive Capture

The gripper linkage mechanism supports envelope adaptive grasping, which is more stable to grip round, spherical or special-shaped objects.

● Plug & Play

It supports plug & play with most collaborative robot brands on the market which is easier to control and program.

● Long Stroke







The biggest stroke of the AG series is up to 145 mm. One gripper can meet the grasping needs of objects of different sizes with good compatibility.

Application

Cooperate with collaborative robot or industrial robot to complete material handling, loading and unloading, assembly, testing, sorting and other tasks in auto parts, automation equipment, new energy and other industries.



Parameters

Product Parameter						
Gripping force (per jaw)	10~65 N					
Stroke	106 mm (parallel) 122 mm (centric)					
Recommended workpiece weight *	1.8 kg					
Opening/Closing time	0.7 s/0.7 s					
Repeat accuracy (position)	± 0.03 mm					
Noise emission	< 50 dB					
Weight	1.68 kg					
Driving method	Screw nut + gear drive + linkage mechanism					
Size	213.5 mm x 170 mm x 118 mm					
Working Environment						
Communication interface	Standard: TCP/IP, USB2.0, CAN2.0A Optional: EtherCAT					
Rated voltage	24 V DC ± 10%					
Rated current	0.5 A					
Peak current	1 A					
IP class	IP 40					
Recommended environment	0~40°C, under 85% RH					
Certification	CE, FCC, RoHS					
						
Build-in Controller	Gripping Force Adjustable	Position Adjustable	Speed Adjustable	Drop Detection	Plug & Play	Self-locking Mechanism



Vertical Maximum Force

Fz: 150 N

Allowable Moment

Mx: 2.5 N·m

My: 2 N·m

Mz: 3 N·m

*It depends on the shape of the grasping object, the material and friction of the contact surface, and the acceleration of the motion, if you have any questions, please contact us.

Technical Drawings

